



Warranty and Service Guidelines and Policy

Victron Energy B.V.



I CONTENTS

2	Introduction	2
2.1	Warranty conditions.....	2
2.2	The role of the Victron Energy customer	3
2.3	The Victron Energy service department.....	3
2.4	Victron Energy Service Partner.....	4
2.5	Self-repairing customer	4
3	Warranty and service procedures.....	5
3.1	Lodging a warranty claim	5
3.2	Lodging a service request for a product that is outside warranty.....	6
3.3	Applying for a credit	6
3.4	E-RMA instructions	6
3.5	What can be expected after a claim or a service request is lodged	8
4	RMA Packaging and shipping instructions	10
4.1	Shipping instructions:.....	10
4.2	Packaging instructions.....	10
4.3	Transport costs.....	11
4.4	Installation costs.....	11
5	Diagnostics	12
5.1	Elimination of external and system faults.....	12
5.2	Non-warranty.....	13
5.3	Basic testing guidelines	14
6	Victron Energy limited warranty policy	17

2 INTRODUCTION

This document will assist you in lodging warranty claims and service requests with our service department. Please try to follow the procedures in this document at all times. They may sound a bit overdone at times but you will be surprised how many units are deemed to be faulty, while the fault could have easily been identified and rectified in-situ. Therefore, these procedures can save you many hours in removing and replacing units as well as unnecessary labour cost, freight costs and frustration.

Please always consult a product's user manual prior to commencing any servicing on our products. Our manuals contain all the necessary safety warnings and instructions. Manuals of all our products, past and present, can be found on our website www.victronenergy.com.

The first part of this document is meant as a guide, to clarify our general service and warranty policy and procedures. Please note that the "Victron Energy Limited Warranty policy" always overrules this document. This policy can be found in chapter 6.

The abbreviation RMA stands for Return Material Authorization
The Victron Energy Service Department in The Netherlands is referred to in this document as the "Service Department".

2.1 WARRANTY CONDITIONS

Victron Energy warrants the performance of all units for a certain period effective from the invoice date.

Warranty to end users:

- Li-ion batteries: 3-year limited warranty
- Lead-acid batteries: 2-year limited warranty
- All other products: 5-year limited warranty

Warranty to distributors:

- Li-ion batteries: 3-year limited warranty
- Lead-acid batteries: 2.5-year limited warranty
- All other products: 5.5-year limited warranty

The warranty applies only on production and/or development faults.

Warranty is on parts only. Warranty does not cover labour costs, costs associated with un-installing, re-installing and transport costs. Warranty repairs are performed, free of charge by the Service Department or a Service Partner. For the full warranty conditions please see the "Victron Energy Limited Service Policy" in chapter 6.

As from the first of January 2015 the warranty has been increased to 5.5 years for most products. The warranty to distributors used to be 30 months. The new 5.5-year warranty applies to units purchased from the first of January 2015 or for units with serial number 14 and above (except for batteries).

Any unit older than this does not fall under warranty. In a few cases we can decide to cover older units under warranty or part warranty, but only after communication with the service department. In some cases, the service department can offer a replacement unit for a discounted price.

To get an idea of the age of the unit, rather than getting the date of the original invoice, you can also look at the serial number. The first two digits stand for the production year and the next two digits stand for the production week. For example: serial number HQ1247XXXXX means that this unit was built in 2012, in week 47 of that year. Please do keep in mind that it can take time between the date a unit is build and the date a unit is sold.

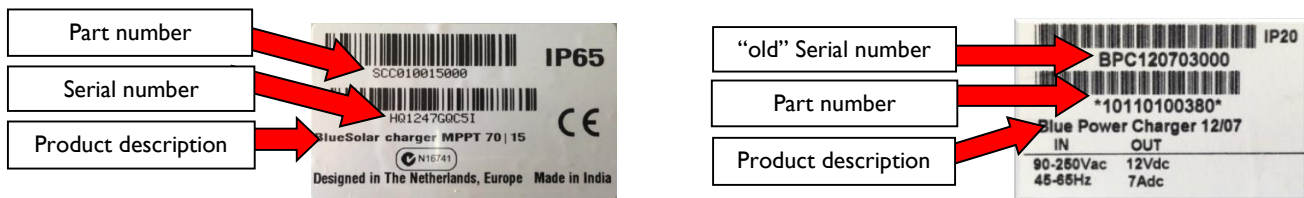

The Service Department keeps a register of serial numbers. They use this register to see when and to whom a particular unit was invoiced together with the history of that unit. They can see if a unit has had previous service or warranty issues.

2.2 THE ROLE OF THE VICTRON ENERGY CUSTOMER

We expect our customers to play an active part in the warranty and service process. We expect you to perform the first line of service. This consist of the following points:

- First-line service and assistance to your customer or to the end-user
- Testing or service on the premises of your customer or the end-user
- Diagnosing and testing faulty equipment and providing a fault report
- Advising customers on proper use of Victron Energy products
- Explanation to the customer about repairs and probable cause of defect

In case of warranty you are responsible for checking or executing the following points:

- Check if there is a possibility of damage by water or dirt
- Check to make sure that the customer has not tried to repair the unit or parts of the units (e.g. soldering)
- Bench testing a unit in your workshop to check functioning of that unit
- Check to see if a unit is suited to its application
- Lodgement of a warranty claim via E-RMA with the service department

2.3 THE VICTRON ENERGY SERVICE DEPARTMENT

The Victron Energy Service department takes care of after sales, service and warranty. They are based in The Netherlands. The Service department is staffed by Jaggat Sewsahai, Denise Streunding, Parwesh Bodha and Hannelien le Nobel.

The function of the Victron Energy service department is:

- Telephone help-desk
- Repair of units
- Liaising with Victron Service partners
- Feedback of information from the field to our production and development departments

Repair time

Victron Energy will at all times try to repair or replace within 5 working days.

Urgent repairs will be done by using exchanging units or circuit boards, either by the Victron Energy dealer/distributor or by the various Victron Energy Service Partners.

Contact details

Email address: service@victronenergy.com

Or contact by phone on +31 36 535 9703.

Opening times are Monday to Friday from 8:30 until 17:00 (Central European time zone). Except Dutch public holidays.

When emailing with the service department please make sure to make mention of our RMA number in the email subject line of your email.

2.4 VICTRON ENERGY SERVICE PARTNER

In certain parts of the world, mainly outside Europe, Victron Energy operates in conjunction with Service Partners. Service Partners are dedicated and very technically capable Victron Energy dealers or distributors who have been set up by Victron Energy to perform product repairs on behalf of the Service Department. They are listed in the “where to buy” section of our website: <http://www.victronenergy.com.au/where-to-buy>. They are recognisable by the sentence: “also Service Partner” behind their company name.

All warranty and service requests have to be initially lodged at the Victron Energy Service Department. Do not contact a Service Partner until advised by the service department. The Service Department will direct you to send the faulty unit to a Service Partner.

If you send a faulty unit to a Service Partner without having been directed by the service department you might be charged with investigation and/or repair costs for work performed by that Service Partner.

In case of equipment that is outside the warranty period you may contact a service partner directly, all costs will be charged to you.

2.5 SELF-REPAIRING CUSTOMER

In certain parts of the world, mainly outside Europe, Victron Energy operates in conjunction with self-repairing customers. These customers have received training from Victron Energy on how to perform repairs through circuit board exchange. These are technically capable customers and repairs are carried out by electrical technicians within that company. These customers are indicated by a tool symbol “” behind their company name in the “where to buy” section of our website: <http://www.victronenergy.com.au/where-to-buy>.

3 WARRANTY AND SERVICE PROCEDURES

3.1 LODGING A WARRANTY CLAIM

Warranty claims have to be lodged on-line, via E-RMA.

E-RMA is part of our E-order website and can be found through a link on website. Please see chapter 3.4 for E-RMA instructions.

If you do not have a log-in for E-RMA then contact the Service Department or your local sales manager.

Please make sure when lodging a warranty claim to always include the following:

- Part number
- Product description
- Serial number
- Firmware version, only needed for inverter/chargers
- Concise fault description
- Photos
- Contact person details

The part number, the serial number and the product description can be found on the sticker on the back of the unit and in our larger models also on the inside of the unit, visible after the front plate is removed.



The firmware version can be found on a sticker on the large black chip on the control circuit board or via the VE.Configure software.

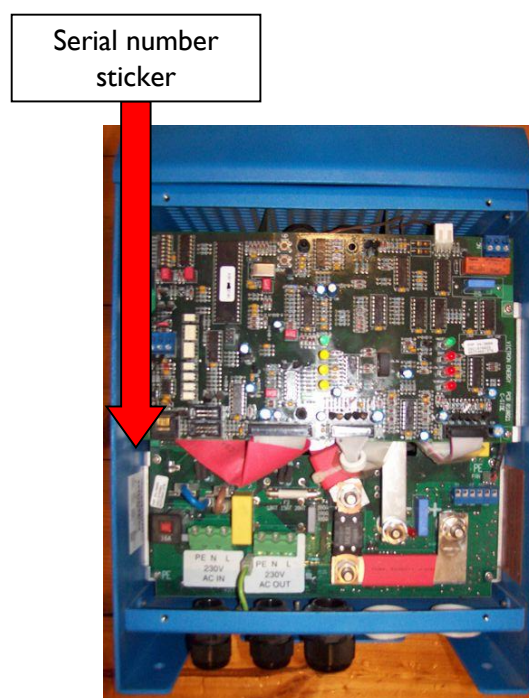
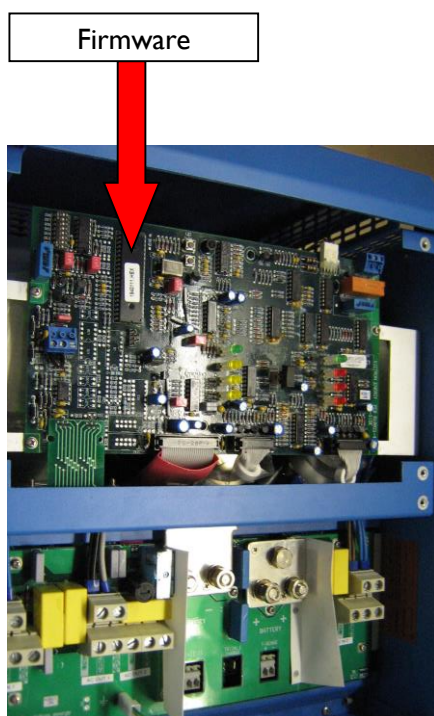

Please provide a fault description as complete as is possible. It is very important that you provide a good fault description together with your claim. Simply mentioning: “The unit does not work” is not a sufficient fault description.

This is an example of a better fault description: “The unit is completely dead when turning it on. The battery voltage on the battery terminals inside the unit is 12.6 Volt.”

The more information you include, the easier it is for the Service Department to act. It will reduce the total repair time, because less questions will need to be asked.

Please see chapter 4 for information on how to correctly diagnose product faults.

In some cases you do not necessarily need to test the unit yourself. If the customer has given you a good fault description you can use that description to lodge the E-RMA warranty claim.

Exceptions:

Parallel or three-phase installations:

In case of parallel or three-phase installations please include additional information (how many, what type of configuration and which unit is faulty). Have you been able to reproduce the error on the test bench? Include details on tests performed. Have you tried resetting the settings to default, to rule out configuration errors?

Battery warranty claims:

In case of a battery warranty claim please lodge the warranty claim and also follow this up with an email to the service department continuing the following information:

- Original purchase invoice
- Information about the system
- Photos
- BMV historical data (without BMV no warranty)

Please do not return batteries to the service department.

Transport damage:

In case of transport damage during regular order shipments, you will need to contact our Orderdesk instead of the Service Department.

3.2 LODGING A SERVICE REQUEST FOR A PRODUCT THAT IS OUTSIDE WARRANTY

It is possible to request a repair for a unit that is outside warranty. The same procedure as lodging a warranty claim applies. Please be aware that costs will apply for repairs outside warranty.

When you lodge the RMA request please mention if you need a quotation or if you need a quotation when costs are more than a certain amount.

3.3 APPLYING FOR A CREDIT

Please note that we never issue credits, we always replace or repair. If you have an issue with a unit, please always lodge an E-RMA straightaway. Ordering a new unit and then expecting a credit at a later stage is not part of our policy.

When new (non-faulty) units have to be credited you will need to contact our Orderdesk instead of the Service Department.

3.4 E-RMA INSTRUCTIONS

Step 1

Go to our website www.victronenergy.com

Victron Energy Warranty and service guidelines Rev. 08

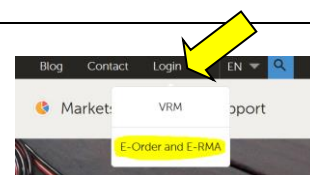

Click on Login
Click on E-Order and E-RMA

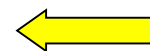

Step 2

Select on the top left of the screen the “E-RMA” link

Report a bug | **E-RMA** | Shipments | Account | Invoices | Backorders | Download product list | Quote copier | Upload CSV/XLS file



mleefink@victronenergy.com | English | Change password | Logout

Step 3

Select Create new RMA on the right

Report a bug | E-RMA | Shipments | Account | Invoices | Backorders | Download product list | Quote copier | Upload CSV/XLS file

mleefink@victronenergy.com | English | Change password | Logout



Create new RMA

Step 4

Complete the short RMA form.

We need:

- Your reference number
- Serial number
- Product number and type
- Reason for return i.e. fault description

Click “Submit new RMA” to submit the form.

Create new RMA

Your reference: 15.0004

Serial number: HQ1247GQ75I

Product: CIN121620000 - Phoenix Inverter Compact 12/1600 - 230V

Reason for return

Provide a fault description as complete possible. In case of parallel or three-phase installations, include more information (how many, which unit is this). Have you been able to reproduce the error on the test bench? Include details on tests performed. Have you tried resetting the settings to default, to rule out configuration errors?

The unit is completely dead when turning it on. The battery voltage on the battery terminals inside the unit is 12.6 Volt. The DC fuse has bene tested and is not faulty.

Language:

English

Submit new RMA

Back to list

Step 5

After submitting the system shows an overview of all RMA’s with the new entry on top.

- Select the RMA ID: link to look at the RMA details page
- Select the PDF “Download” link to download RMA packing list and the packaging label
- Click the create new RMA button to lodge the next warranty claim

New RMA has been successfully saved to database.



Create new RMA

Overview RMA

RMA ID:

[208.412](#)
2015-11-29



Item:

CIN121620000
HQ1247GQ75I

Product:

Phoenix Inverter Compact
12/1600 - 230V

Fault description:

The unit is completely dead when turning it on. The battery voltage on the battery terminals inside the unit is 12.6 Volt. The DC fuse has bene tested and is not faulty.

Your reference:

15.0004

Status:

Open

PDF:

[Download](#)



Response:

Step 6

The downloadable PDF document

- The first page is a packing list and must always accompany the product within the package

- The second document is the shipping label that you affix to the outside of the package

Outside Europe only:

Customers outside Europe do not have to send the goods back to the Service Department, but to a Service Partner.

Do not use the shipping label.

Send the goods to the address provided by the Service department.



Packing list



Shipping label

3.5 WHAT CAN BE EXPECTED AFTER A CLAIM OR A SERVICE REQUEST IS LODGED

As soon as you have lodged an E-RMA it will appear in the overview list and you have also been issued with an RMA number. Please use this RMA number in all your communication with the Service Department.

New RMA has been successfully saved to database.

Create new RMA

Overview RMA

RMA ID:	Item:	Product:	Fault description:
208.412 2015-11-29	CIN121620000 HQ1247GQ75I	Phoenix Inverter Compact 12/1600 - 230V	The unit is completely dead when turning it on. The battery voltage on the battery terminals inside the unit is 12.6 Volt. The DC fuse has been tested and is not faulty.
Your reference: 15.0004	Status: Open	PDF: Download	
Response:			

Service department will get back to you once you they have processed your claim. The reply from the service department could be any of the following:

- Service department will ask you additional questions or will ask for photos
- Warranty approved and you have to send the unit for repair to the Service department (or to a Service Partner)
- Warranty approved and a replacement unit will be sent to you
- Warranty approved, if you are a self-repairing customer the Service Department will send you replacement circuit board(s)
- Warranty not approved, you can choose to have the faulty repaired at cost
- Warranty not approved, we can make an offer for a replacement unit for a special price
- Warranty not approved, we can send you replacement board(s) at cost

For inside Europe:

Please send a faulty unit to the Service Department in The Netherlands.

For outside Europe:

Please never send a faulty unit to the Service Department in The Netherlands or to a Service Partner unless you have received specific instruction to do so from the Victron Energy Service Department.

If a unit is sent for repair and no warrantable fault is found, we will charge investigation costs and the unit will not be repaired. In this circumstance we will only repair the unit after you have agreed to pay for the repair costs.

In some cases, such as older non repairable units, we can offer a replacement unit for a discounted special price. If you want to make use of this offer you will need to send your purchase order to the Service department. You will have to mention the RMA number and the special price in your purchase order.

If you order the unit for a special price from the Orderdesk, you will be charged the normal price.

Once a RMA is realized it will be shown in the E-RMA overview. The status will have changed from “open” to “realized” and the response from the service department has been added.

RMA ID: 208.388 2015-11-27	Item: CYR010225000 HQ1306Q2ZK2	Product: RMA 208.388 / HQ1306Q2ZK2	Fault description: When the battery voltage is high enough, you can hear the relay click, but the two Battery + terminals are not connected. It appears that the logic inside the unit is working, but the relay mechanism has failed.
Your reference:	Status: Realized	PDF: Download	
Response: New Cyrix-ct 12/24-230A battery combiner delivered under warranty because of defective Cyrix-i 12/24-225A. (RMA 208388) S/N defective unit:HQ1306Q2ZK2			

4 RMA PACKAGING AND SHIPPING INSTRUCTIONS

4.1 SHIPPING INSTRUCTIONS:

- Print the RMA PDF document
- Properly pack the product
- Add the first page of the PDF document inside the package
- Also include your return address
- If the package is send to the Service Department, please affix the RMA shipping label to the outside of the package. Make sure the RMA number is visible
- If the package is send to a service Partner, please do not use the RMA shipping label but address the package to the address supplied by the service department.

For batteries:

Batteries do not have to be returned, please email photos instead.

For customers inside Europe:

If the return address is different from the standard delivery address we have on file for you, we will charge a 35 Euro delivery fee.

For customers outside Europe:

Please only send units to the Service department or service partner after having been instructed to do so by the service department. In some cases faulty products do not have the be send back at all. We ask that you keep the faulty units on your premises, until your local Victron Sales manager has viewed these units.

4.2 PACKAGING INSTRUCTIONS

To prevent transport damage please ensure that all units are shipped with sufficient packaging. We would prefer if you use the original box.

Do not add manuals, non-original cables or mounting materials to the package.



Care for proper packaging to prevent damage; it is good practice to wrap the product in a plastic bag or in foil.



Packages over 25 kg must be shipped on a pallet.



Exceptions:

- When returning a VGR2 or VER, please include all cables.
- When returning a BMV it is sufficient to send the BMV display and/or the small shunt circuit board. It is not necessary to dismount the complete shunt and send it and or the cables to us.

4.3 TRANSPORT COSTS

The customer is liable for the transport costs of units being sent to the Service Department or a Service Partner. Warranty repairs are returned to the customer on Victron Energy costs. Non-warranty repairs are returned on the customer's costs.

4.4 INSTALLATION COSTS

We do not refund any cost made by un-installation and re-installation of our products.

5 DIAGNOSTICS

Prior to diagnostics read the applicable product manual. Please pay special attention to the safety guidelines for the product manual. The manual also contains fault finding and diagnosing information.

5.1 ELIMINATION OF EXTERNAL AND SYSTEM FAULTS

A Victron Energy product is always part of a system. It is therefore necessary to pay special attention to that system. For example, a Multi can appear to be faulty, while in reality something else in the system could be causing the apparent Multi fault.

This is an example of a system where a Multi is most often part of:

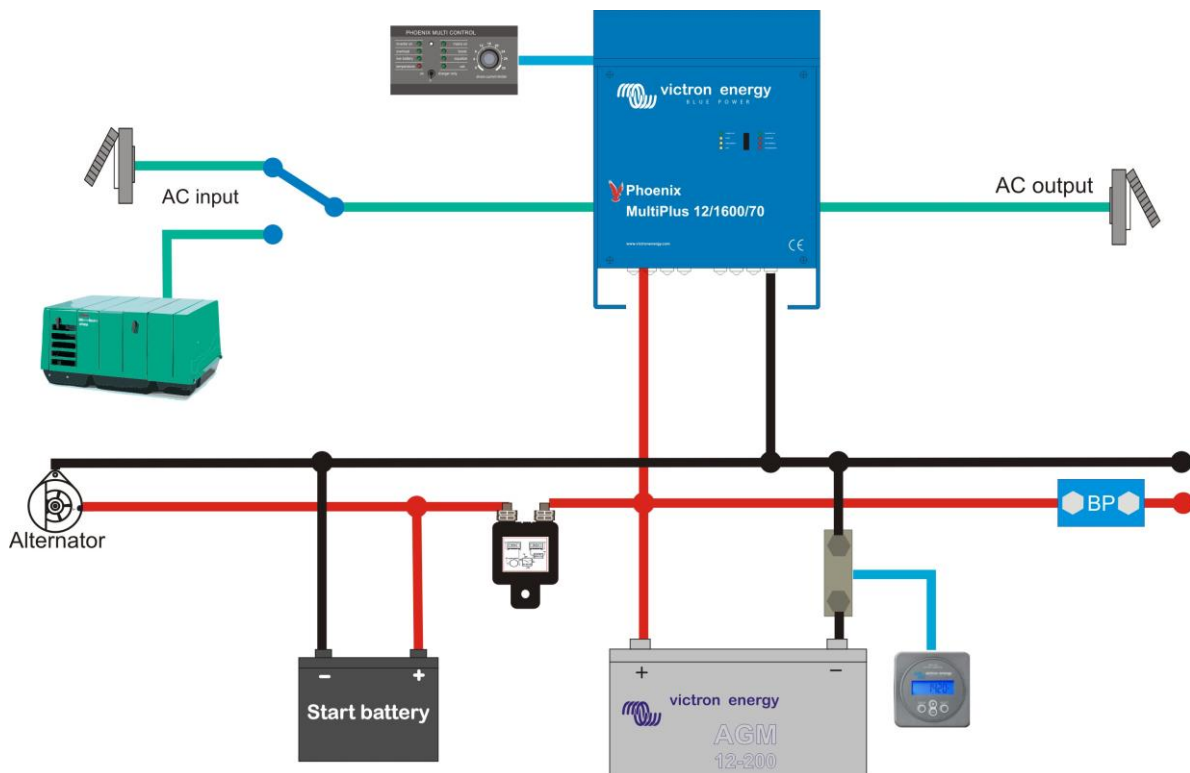

As you can see there are many components in this system that can cause an incorrect operation of the Multi. A Multi is after all dependent on many inputs and outputs. Please see below for a list of the most common items that connect to Victron products and some pointers to look out for when checking a system external from Victron product.

Batteries

Batteries are one of the most important external factors.

The battery cabling needs to be of a suitable thickness. The fuses, battery isolators and battery connections need to be in good shape and all cable connections need to be clean and tight. If any of these are of sub-standard quality a voltage loss and/or a ripple voltage can occur. This will cause a Victron product to shut down. Please see the product manual for a table on recommended battery cable thicknesses.

Batteries can cause a lot of strange symptoms in a Victron product when the battery is:

- Empty or almost empty
- Capacity too small
- Bad quality or too old
- Too hot or too cold

A battery problem can make a Victron product appear to be faulty. In case of a Multi you can see: a totally dead unit, a low battery light or the overload and low battery light blink or light up simultaneously. In this case the first point of action is to measure the battery voltage under no load and under load. If the battery voltage drops significantly under load the batteries are empty or faulty.

Undercharged batteries are most often due to a large DC load in the system. The DC loads in a system can consume more power than the Multi or the charger can deliver. Another reason for undercharged batteries can be that the batteries are too large for the charger.

Overcharged batteries can be caused by a very small or faulty battery bank.

Ac input and output

Multis can connect to mains and also can connect to generators. Depending on the quality of the output voltage of the generator, some settings in the Multi need to be changed. See the manual and also the help files in VE.

Configure to help you adjust a Multi to certain generators.

Problems with the AC output usually stem from too many appliances or too large appliances connected to the Multi. A fault in one of the connected appliances or a short circuit in one of the connected appliances can also lead to a problematic AC output. Keep in mind that there also could be a fault in the AC wiring itself. These kinds of faults are often indicated by a blinking or illuminated overload light or tripping circuit breakers, RCD's and automatic fuses.

In some cases, an AC wiring mistake could have been made in where accidentally the AC input is connected to the AC output

The best way to determine if the fault is in the Multi or in the AC system around the Multi is to bypass the Multi. That is to connect the AC input to the AC output, without the Multi being in the system. If the fault still occurs the cause is naturally external from the Multi.

Accessories like control panel and temperature sensor

Remember that for the control panel to work, the main on/off switch will need to be set to the “on” position.

A broken, wrongly wired or missing cable between a Multi and a remote control panel are often the cause for the remote panel not to work.

The temperature sensor is sometimes connected to the wrong terminals, or the sensor is faulty or damaged. This is most often indicated by blinking temperature light on the Multi.

5.2 NON-WARRANTY

Warranty approval can only be decided by our service department, but in many cases you will be able to tell straight away if a faulty unit broke down outside of warranty.

The following instances are not covered under warranty:

Water damage

The unit needs to be checked internally and externally. The external evidence is usual removed by the customer. It is therefore very important that an internal visual check is performed. Please pay special attention to corrosion or dried water marks. Also inspect on and around the circuit boards or on any mechanical parts.

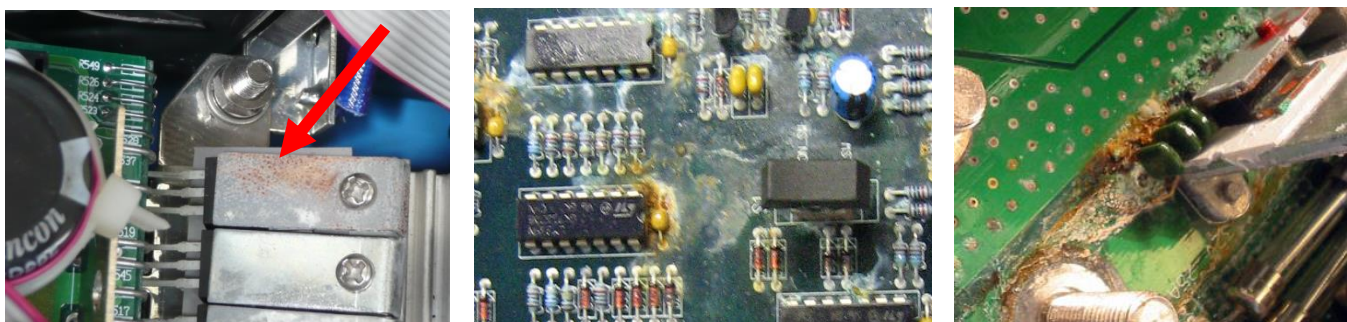

Presence of dirt and soot inside the unit

An evident present of dirt, dust or soot will also void the warranty. Soot is the biggest culprit, as it contains carbon which conducts electricity and will cause a lot of damage.

Reverse polarity

Reverse polarity is when the negative battery cable is connected to the positive Multi terminal and vice versa. Most of the time people do not purposefully mix up the cables, but reverse polarity is caused by a wiring mistake or wrongly labelled cables. Reverse polarity can usually only be detected by a electrical technician. In some cases the customer will tell you about it, or you might notice the wiring mistake yourself.

Lightning strikes and power surges

Lightning strikes and power surges are not always evident. This can usually only be detected by an electrical technician. But in most cases the customer will tell you about this, or many more electrical devices broke down at the same time.

Insects and other pests

Insects and other pests, even mice can get into the unit and cause a short circuit someplace inside the unit. In most cases they are visible after opening the unit and when closely inspecting inside.

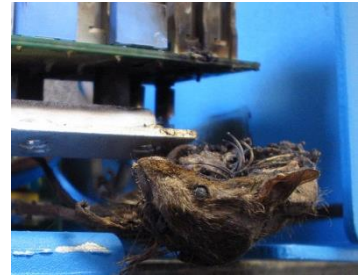

Mechanical damage

Mechanical damage can be anything from clearly dented cases, to accidental holes drilled into the units casing, straight through an essential internal part. It is therefore necessary to always thoroughly visually inspect the outside and inside of the unit. Also look for loose items present inside the unit, like foreign items such as metal filings and bits of electricity cable.

Another item that gets easily damaged are the AC and DC connectors. The bolts and screws that make up these connectors are made of copper and can break when excessive force is applied when tightening.

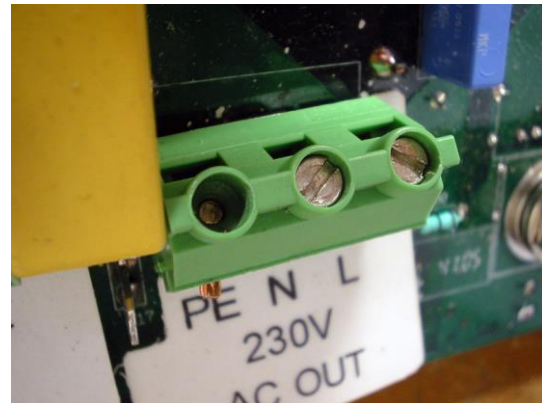
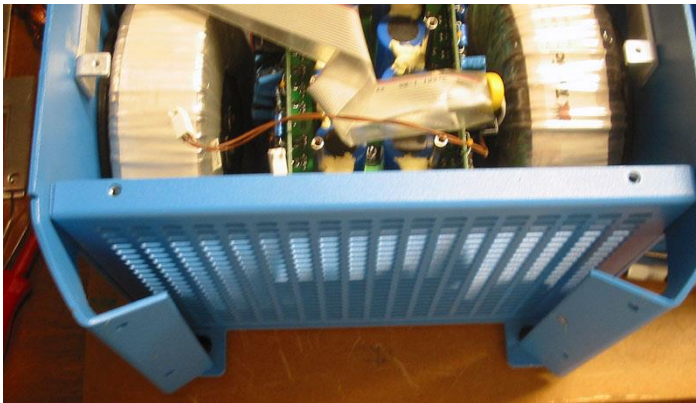

Age of unit

The warranty duration of our various products can be found in this document and can also be found in the bottom of our price lists. Depending on the product group different warranty lengths apply. Any unit older than this does not fall under warranty. In a few rare cases we can decide to cover older units under warranty, but only in exceptional circumstances and after communication with the service department.

5.3 BASIC TESTING GUIDELINES

These testing guidelines are written for diagnosing and testing inverter/chargers but it can also apply to a single inverter or a single charger.

In the following chapter we mention the word Multi, with Multi we mean an inverter/charger, this can be a MultiPlus, a Multi Compact, an EasySolar a Quattro and so on.

A Multi or Quattro test always has to be performed in the following order:

Visual check and preparing a unit for diagnostics:

- Turn unit off
- Disconnect or turn off all AC loads.
- Disconnect or turn off all DC loads.
- Disconnect the AC input.
- If connected, disconnect remote panel.
- Perform internal visual check on the following:
 - Broken or missing fuses
 - Burn marks or burn smell
 - Water damage
 - Corrosion
 - Dust or dirt
 - Damaged or incomplete wiring
- Check the Mega fuse (if present).
 - Remove or short (just for testing purposes) the Mega fuse
 - Inspect fuse for mechanical damage
 - Test fuse with multi meter (the fuse needs to be removed for this test)
 - Replace fuse if fuse is faulty.
 - Re-insert fuse.

Checking Inverter operation

- Check correct battery voltage is present at the DC terminals inside Multi.
- Turn Multi off for at least 10 seconds.
- Turn Multi on.
- Connect VE.Configure, use VE.Configure for measurement purposes.
- Check if the green inverter LED is illuminated.
- Refer to the manual if any red LEDs are illuminated or blinking.
- Check the operation of the inverter by measuring the AC output.
- Connect an AC load and check the operation of the inverter.
- Increase the AC load to the Multis rated power.
- Disconnect the AC load.

Checking transfer from inverter to charger:

- Connect the AC input and check if Multi switches from inverting to charging. This can take some time (this can take up to 1 minute if a bad quality generator is connected).
- Disconnect the AC input and check if Multi switches from charging back to inverting.
- In case of a Quattro, repeat this test for the 2nd AC input

Checking Charger operation:

- Connect the AC input and check if the Multi switches from inverting to charging. This can take some time.
- Check if the green “mains on” LED is illuminated.
- Check if any of the amber charger LEDs are illuminated.
- Refer to the manual if any red LEDs are illuminated.
- Check the operation of the charger.
- Connect temp sensor, heat the sensor and verify if the charge voltage drops.
- Connect an AC load and check if this load gets powered by the Multi.
- Switch the unit to “charger only” and check if the unit charges correctly
- Multis will act as power supplies when only AC connected and no battery is connected.

Checking power assist (only for units, 1200VA and above)

- Check if the Multi is a MultiPlus unit or a Quattro.
- Increase the AC load and check if the Multi starts power control. The charge current to the battery should reduce.
- Increase the AC load even further and check if the Multi starts power assisting. This is indicated by a flashing Inverter LED and a reversal of the battery current.

For more in depth testing procedures and hints and tips, please see the “Victron Service manual” This booklet is available upon request form the service department or from your local sales manager.

6 VICTRON ENERGY LIMITED WARRANTY POLICY

Victron Energy warrants its products to be free from defects in workmanship and materials for a period of 5 years from the date of purchase by the end user, with a maximum of 66 months from the Victron Energy invoice date. Exception are lead-acid batteries: 2 years from date of purchase by the end user, with a maximum of 30 months from the Victron Energy invoice date and Lithium-ion batteries: 3 years from date of purchase by the end user. During this period, Victron Energy will, at its option, repair or replace the defective product free of charge. The warranty does not include performing or reimbursing de-installation, transportation and re-installation. This warranty will be considered void if the unit has suffered any physical damage or alteration, either internally or externally, and does not cover damages arising from improper use like:

- Reverse of battery polarity.
- Inadequate connection.
- Mechanical shock or deformation.
- Contact with liquid or oxidation by condensation.
- Use in inappropriate environment (dust, corrosive vapor, humidity, high temperature, biological infestation...).
- Breakage or damage due to lightning.
- Connection terminals and screws destroyed or other damages, like overheat, due to insufficient tightening.
- For any electrical breakage except due to lightning (reverse polarity, over-voltage due to external cause), the state of the internal control diode and of the inputs/output X and Y capacitors determine the warranty.

This warranty will not apply where the product has been misused, neglected, improperly installed, or repaired by anyone else than Victron Energy or one of its authorized Qualified Service Partners. In order to qualify for the warranty, the product must not be disassembled or modified.

Repair or replacement are our sole remedies and Victron Energy shall not be liable for damages, whether direct, incidental, special, or consequential, even caused by negligence or fault.

Victron Energy owns all parts removed from repaired products. Victron Energy uses new or reconditioned parts made by various manufacturers in performing warranty repairs and building replacement products. If Victron Energy repairs or replaces a part of a product, its warranty term is not extended. In case of replacement the new component has a warranty of 6 months, without effect on the initial warranty period.

All remedies and the measure for damages are limited to the above.

Victron Energy shall in no event be liable for consequential, incidental, contingent or special damages, even if having been advised of the probability of such damages. Any and all other warranties expressed or implied arising by law, course of dealing, course of performance, usage of trade or otherwise, including but not limited to implied warranties of merchantability and fitness for a particular purpose, are limited in duration to a period of two (2) years from the date of purchase.

Life Support Policy

As a general policy, Victron Energy, does not recommend the use of any of its products in life support applications where failure or malfunction of the Victron Energy's product can be reasonably expected to cause failure of the life support device or to significantly affect its safety or effectiveness. Victron Energy does not recommend the use of any of its products in direct patient care. Victron Energy will not knowingly sell its products for use in such applications unless it receives in writing assurances satisfactory to Victron Energy that the risks of injury or damage have been minimized, the customer assumes all such risks, and the Liability of Victron Energy is adequately protected under the circumstances.

Warranty Service

The execution of the warranty services will normally be carried out by the Qualified Service Partner authorized by Victron Energy for the replacement of every parts or any faulty element which does not need special adjustments. Victron Energy assures the exchange of faulty elements or the reparation at the factory. The beneficiary of the warranty must provide all the needed information on the form ad hoc.

As a product requires service, it must be brought back to the place of purchase. In case no contact can be taken with the merchant, or if he is either unable or not allowed to provide service, direct contact should be taken with Victron Energy.

In the same time, the serial number of the product, the date of purchase and the name of the merchant will be required. The faulty material must be sent - at the sender own expenses back to our closest Qualified Service Partner (address upon request) or to our factory.

Warranty on repairs

The warranty period on products or on printed circuits boards repaired by Victron Energy as well as on printed circuit boards for replacement is 3 months from delivery by Victron Energy.

CAUTION: inverters are heavy materials. The transport must be organized in a way to avoid any damage, especially when a single unit is sent. More than this, the warranty can be applied only if the product is returned with its individual Return form.

Severability

If a part of the terms and conditions set out above is held invalid, void or unenforceable due to any particular national or international legislation, it shall not affect other parts of the terms and conditions remaining.